

Features

- SMD Single-Turn / Cermet / Industrial Open Frame
- Cross slot rotor designs suitable for automatic adjustment equipment
- Supplied in 12 mm embossed tape, compatible with automatic pick-and-place assembly equipment
- Recommended for reflow solder processing only
- RoHS compliant* - see [processing information](#) on lead free surface mount trimmers
- For trimmer applications/processing guidelines, [click here](#)

3364 - 4 mm Square Trimpot® Trimming Potentiometer

Electrical Characteristics

Standard Resistance Range100 ohms to 1 megohm
 (see standard resistance table)
 Resistance Tolerance ±25 % std.
 End Resistance
 <1K.....20 ohms max.
 >1K.....2 %
 Contact Resistance Variation
 (Voltage Divider) 5 % max.
 Resolution Infinite
 Adjustment Angle 260 °±20 °

Environmental Characteristics

Power Rating (50 volts max.)
 70 °C 0.2 watt
 Temperature Range ... -40 °C to +100 °C
 Temperature Coefficient ... ±250 ppm/°C
 Humidity500 hours (5 % ΔTR)
 Load Life.....500 hours
 0.2 watt @ 70 °C (5 % ΔTR)
 Rotational Life 20 cycles (15% ΔTR)

Physical Characteristics

Torque.....20 to 200 g-cm
 Mechanical Angle Continuous
 Marking..... Resistance code,
 manufacturer's full part number
 and date code on packaging
 Terminals Solder coated
 Standard Packaging... 1000 pcs./7 " reel
 Adjustment Tool..... H-90

Aqueous cleaning not recommended.
 Reflow solder processing recommended

How To Order

3364 X - 1 - 103 E

Model _____
 Style _____
 Orientation of parts in tape:
 Styles W,A
 Terminals toward sprocket holes
 Styles X,B
 Terminals away from sprocket holes
 Standard Product _____
 Resistance Code _____
 Embossed Tape Designator _____
 E = 1000 pcs./7 " reel (-1 standard)

Consult factory for other available options.

Product Dimensions

Common Dimensions
 3364W, X
 3-Terminal

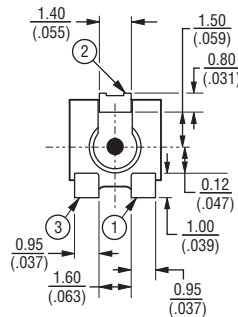
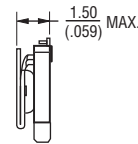
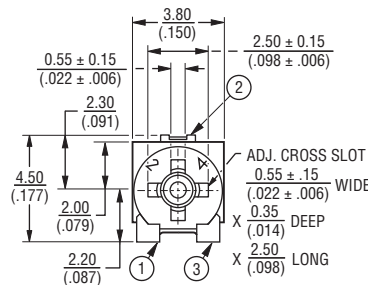

SUGGESTED PWB LAYOUT

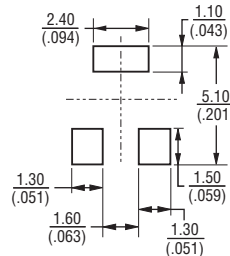

DIMENSIONS: $\frac{\text{MM}}{\text{(INCHES)}}$
 TOLERANCES: ± $\frac{0.25}{(.010)}$ EXCEPT WHERE NOTED

3364A, B
 3-Terminal

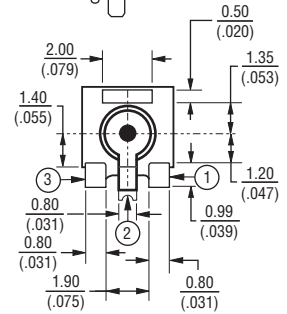
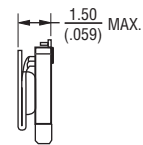
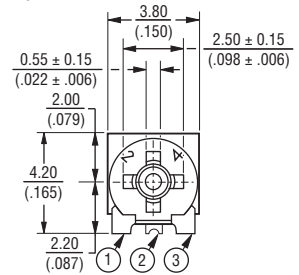

SUGGESTED PWB LAYOUT

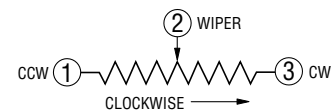
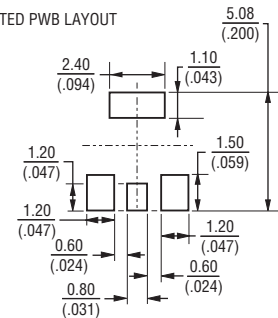

*RoHS Directive 2002/95/EC Jan. 27, 2003 including annex and RoHS Recast 2011/65/EU June 8, 2011.
 Specifications are subject to change without notice.

The device characteristics and parameters in this data sheet can and do vary in different applications and actual device performance may vary over time.
 Users should verify actual device performance in their specific applications.

3364 - 4 mm Square TrimPot® Trimming Potentiometer

BOURNS®

Packaging Specifications

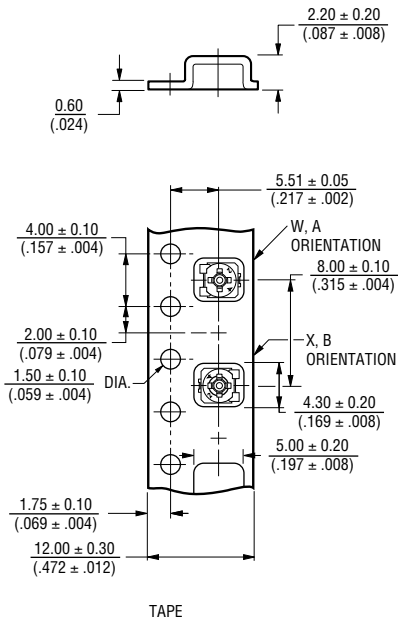

Standard Resistance Table

Resistance (Ohms)	Resistance Code	Part Marking
100	101	12
200	201	22
500	501	52
1,000	102	13
2,000	202	23
5,000	502	53
10,000	103	14
20,000	203	24
50,000	503	54
100,000	104	15
200,000	204	25
500,000	504	55
1,000,000	105	16

Popular distribution resistance values listed in boldface.

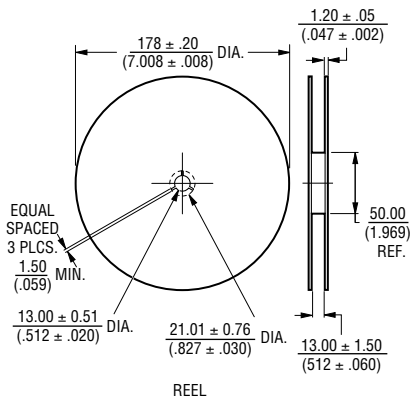

Conforms with EIA specification RS-481.

DIMENSIONS: $\frac{\text{MM}}{\text{(INCHES)}}$

REV. 04/13

"TrimPot" is a registered trademark of Bourns, Inc. Specifications are subject to change without notice.

The device characteristics and parameters in this data sheet can and do vary in different applications and actual device performance may vary over time. Users should verify actual device performance in their specific applications.